



## Avaloir de so avec

## vlies-kaschiertem Kunststoffflansch

### Type: HL90PrD

#### Donnés techniques

<b>Fonction:</b>	Avaloir pour balcon et terrasse avec bride d'étanchéité. Tubulure de raccordement horizontale. Faible hauteur d'installation!
<b>Raccordement:</b>	Ø 40 mm
<b>Tubulure de raccord.:</b>	Tube PE, enfichable et soudable
<b>Débit d'écoulement:</b>	24 litres / minute
<b>Siphon:</b>	PRIMUS
<b>Capacité de charge:</b>	Max. 300 kg
<b>Temp. du fluide:</b>	Max. +85°C

#### Données de commande

Art.-No.:	Désignation	Matériaux
<b>HL90PrD</b>	<b>Avaloir pour balcon et terrasse complet</b>	PE
HL37FPr	Support de Grille 123 x 123 mm	PP
HL01067D	Joint torique 92 mm x 4 mm	EPDM
HL037Pr.1E	Grille 115 x 115 mm	Inox V2A
HL2090	Siphon PRIMUS	PP
HL037N.0E	Couvercle de protection carré	ABS
HL0300.0EN	Couvercle de protection ronde	ABS

#### Encombresments [mm]

**Manchette 500 x 500**

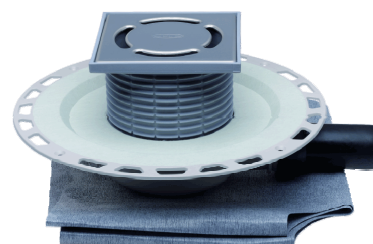
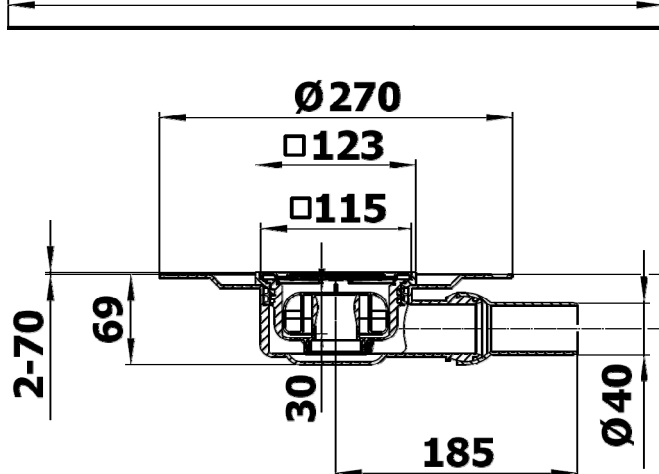

**HL90Pr**



Support de grille

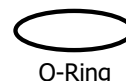

O-Ring



Grille



Siphon



Couvercle de protection de carré / ronde



## Avaloir de sol

### HL90PrD Accessoires

#### Données de commande

Art.-No.:	Désignation	Matériaux
HL85N	Elément de rehausse ø bride d'étanchéité = 220 mm ø l'extension = 110 mm H = 200 mm découplable	<b>PP</b>
HL85NH	Elément de rehausse avec manchette ø Manchette = 420 mm ø L'extension = 110 mm H = 200 mm découplable	<b>PP</b> <b>Bitume</b>
H340N	Elément de rehausse ø l'extension = 110 mm H = 100 mm découplable	<b>PP</b>
HL3120-27	Grille 115 x 115 mm	<b>Inox V4A</b>

#### Options supplémentaires sur demande



HL85N

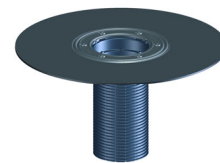

HL85NH



HL340N

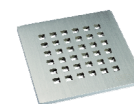

HL3120

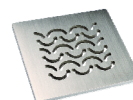

HL3121



HL3122



HL3123



HL3124

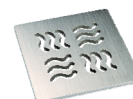

HL3125



HL3127